

Roll-container (1 Ref. 9626_, 3x Ref. 9625_ e 1 Ref. 9635_)



3 Roll-containers rebatidos

Rebatidas com rodízios

Rebatidas sobre palete de 1.2x0.8m

Empilháveis, e também rebatíveis em vazio para minimizar o volume ocupado.



As caixas sem fundo empilham-se sobre outras de forma a duplicar ou triplicar a altura interior.



Caixa sem fundo



Caixa sem fundo empilhada sobre outra com fundo.

Ref. 9620_

Não inclui as pegas apresentadas nas fotos (cada pega é vendida em separado sob a Ref. 9636_).



Ref. 9636_



Caixa com rodízios, montada ou rebatida

A = 590mm

Ref. 9622_



Caixa com portas para acesso lateral

Ref. 9625_

Para acesso lateral existe a versão com portas Ref. 9625_ e também uma versão sem portas, só com abertura lateral Ref. 9628_.

A Tampa Ref. 9635_ permite a colocação de cintas de inviolabilidade.



Caixa com fundo Ref. 9621_ sobre caixa com rodízios.



2 caixas com rodas Ref. 9622_ e Tampas Ref. 9635_

As caixas empilham-se umas sobre as outras, ou sobre as tampas, quer tenham ou não rodízios.

	Ref.	Kg
Sem fundo	9620_	6.6
Com fundo	9621_	8.1
Com fundo e rodízios	9622_	10.2
Com portas	9625_	8.1
Com portas e rodízios	9626_	10.2
Com abertura lateral	9628_	7.5
Com abertura e rodízios	9629_	9.6
Sem fundo, com portas	962P_	6.6
Tampa	9635_	1.8

CAIXAS PARA PICKING

DIM. 183 Ltrs
(ext.) 800 x 600 x 465mm (int.) 760 x 560 x 450mm

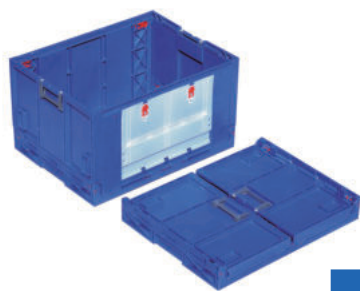

3 caixas com portas
Ref. 9625_ sobre
caixa com portas e
rodízios Ref. 9626_

	Ref.
Com portas	9625_
Com portas e rodízios	9626_
Com abertura lateral	9628_
Com abertura e rodízios	9629_
Tampa	9635_

DIM. 35 Ltrs



140/ 1m

DIM. (ext.) 600 x 400 x 200mm (int.) 530 x 340 x 172mm

Ref. 120P_



130/ 1m

DIM. (ext.) 600 x 400 x 300mm (int.) 530 x 340 x 272mm

Ref. 130R_



130/ 1m

Ref. 130T_

DIM. 53 Ltrs



130/ 1m

Ref. 130P_

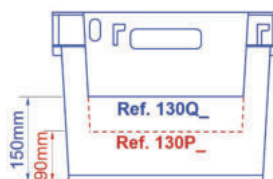

130/ 1m

Ref. 130Q_

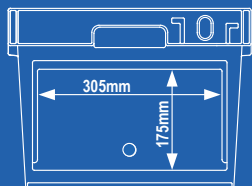

Ref. 1305	Ref. 1306
Com abertura	Com portinhola



130/ 1m

Ref. 1305_



130/ 1m

Ref. 1306_

DIM. (ext.) 600 x 400 x 300mm (int.) 530 x 340 x 272mm

Base com rodízios (600 x 400mm)

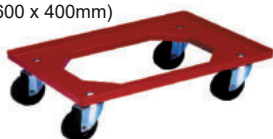

Ref. 9654_



Ref. 9656_

Tampa (600 x 400mm)



Ref. 3006_



PSAplast.com

Plásticos Santo António, Lda.
P.O. Box 21, 2416 - 901 Leiria, Portugal
Tel. 00-351-244 81 36 00
Fax. 00-351-244 81 22 21

comercial@psaplast.com

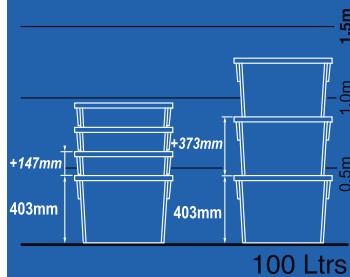

Ref. 3351_

Fechada

DIM.
(ext.) (int.)
620 x 500 x 403mm 540 x 430 x 400mm

Encaixáveis umas nas outras para economia de espaço, bastando dar meia volta à caixa.

Concebidas para possibilitar a movimentação de 4 rimas sobre palete de 1,2 x 1,0m.

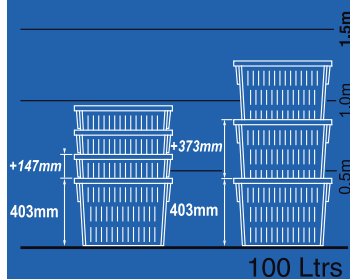

Ref. 3353_

Fundo fechado, lados gradeados

DIM.
(ext.) (int.)
620 x 500 x 403mm 540 x 430 x 400mm

Base com rodízios

Tampa (620 x 500mm)



Ref. 9652_



Ref. 0210_

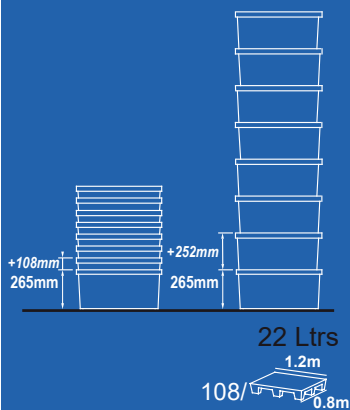

Ref. 4326_

Fechada

DIM. (ext.) 400 x 300 x 265mm (int.) 336 x 254 x 239mm

Encaixáveis umas nas outras para economia de espaço.

Empilháveis sobre as tampas fechadas.

Permitem a colocação de selos de inviolabilidade.

Janela porta-etiqueta disponível em opção.

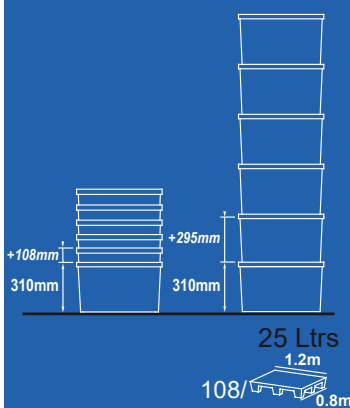

Ref. 4331_

Fechada

DIM. (ext.) 400 x 300 x 310mm (int.) 332 x 250 x 282mm

Clip de
inviolabilidade



Ref. 6402_



Ref. 6405_

Janela porta etiqueta



Ref. 430J_

Base com rodízios (600 x 400 mm)



Ref. 9654_

PSAplast
.com

Plásticos Santo António, Lda.
P.O. Box 21, 2416 - 901 Leiria, Portugal

Tel. 00-351-244 81 36 00
Fax. 00-351-244 81 22 21

comercial@psaplast.com

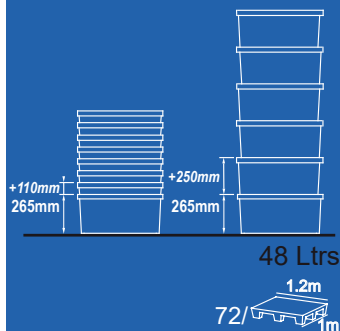

48 Ltrs

72/ 



Encaixáveis umas nas outras para economia de espaço.

Empilháveis sobre as tampas fechadas.

Permitem a colocação de selos de inviolabilidade.

Janela porta-etiqueta disponível em opção.

Ref. 6426_

Fechada

DIM. (ext.) 600 x 400 x 265mm (int.) 530 x 353 x 240mm

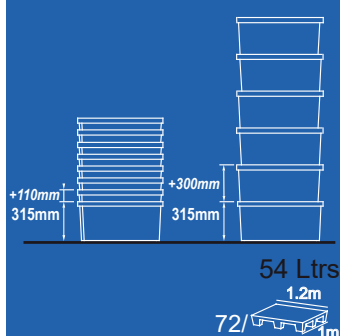

54 Ltrs

72/ 



Ref. 6431_

Fechada

DIM. (ext.) 600 x 400 x 310mm (int.) 514 x 350 x 281mm

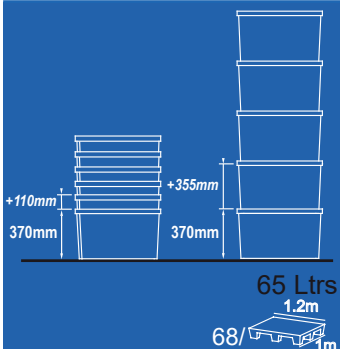

65 Ltrs

68/ 



Ref. 6436_

Fechada

DIM. (ext.) 600 x 400 x 365mm (int.) 508 x 346 x 340mm

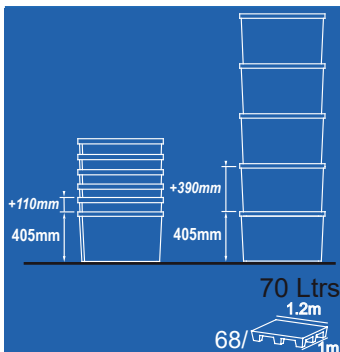

70 Ltrs

68/ 



Ref. 6440_

Fechada

DIM. (ext.) 600 x 400 x 400mm (int.) 521 x 343 x 375mm

Clip de inviolabilidade



Ref. 6402_



Ref. 6405_

Janela Porta Etiqueta



Ref. 640J_

Base com rodízios (600 x 400 mm)



Ref. 9654_

PSAplast
.com

Plásticos Santo António, Lda.
P.O. Box 21, 2416 - 901 Leiria, Portugal

Tel. 00-351-244 81 36 00
Fax. 00-351-244 81 22 21

comercial@psaplast.com

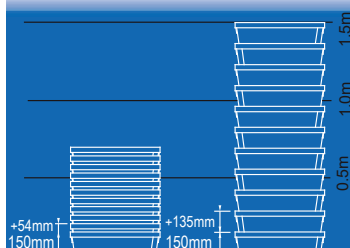

25 Ltrs

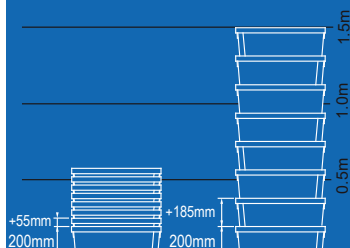

35 Ltrs



195/1m

Ref. 9901_

Fechada

(ext.) DIM. (int.)
600 x 400 x 150mm 490 x 332 x 145mm

Por encomenda, podemos fabricar a caixa de 25L com 150mm de altura toda gradeada (Ref. 9902_).



190/1m

Ref. 9701_

Fechada

(ext.) DIM. (int.)
600 x 400 x 200mm 490 x 332 x 195mm



190/1m

Ref. 9702_

Gradeada

(ext.) DIM. (int.)
600 x 400 x 200mm 490 x 332 x 195mm

Encaixáveis umas nas outras para economia de espaço, bastando dar meia volta à caixa.

A tampa Ref. 3006_ permite a colocação de cintas de inviolabilidade.

Por encomenda todos os modelos podem ser fabricados:

- com lados gradeados e fundo fechado, ou:
- com lados fechados e fundo gradeado, ou:
- com rodízios, lados e fundo gradeados (Ref. 990R, 970R, e 980R):
- com rodízios, lados fechados e fundo gradeado

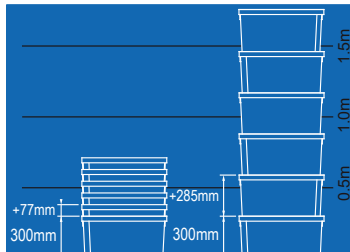

50 Ltrs

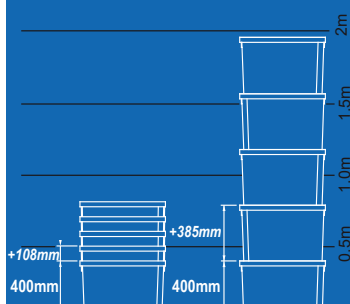

70 Ltrs



130/1m

Ref. 9751_

Fechada

(ext.) DIM. (int.)
600 x 400 x 300mm 490 x 332 x 295mm



130/1m

Ref. 9752_

Gradeada

(ext.) DIM. (int.)
600 x 400 x 300mm 490 x 332 x 295mm



90/1m

Ref. 9801_

Fechada

(ext.) DIM. (int.)
600 x 400 x 400mm 490 x 332 x 395mm



90/1m

Ref. 9802_

Gradeada

(ext.) DIM. (int.)
600 x 400 x 400mm 490 x 332 x 395mm



90/1m

Ref. 980R

Com rodas

Base com rodízios (600 x 400 mm)

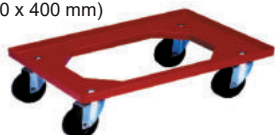

Ref. 9654_



Ref. 9656_

Tampa (600 x 400 mm)



Ref. 3006_

50 Ltrs

130/ 1.2m
1m

 ■ ■ Ref. 2271_	 ■ Ref. 2272_
Fechada	Gradeada
DIM. (ext.) 600 x 400 x 270mm (int.) 490 x 340 x 267mm	

Empilháveis, e também encaixáveis em vazio para minimizar o volume ocupado.

As caixas da série 2000 asseguram um melhor aproveitamento do espaço interior quando comparadas com outras caixas que também empilham ou encaixam através de uma rotação de 180°.

Ao colocar a tampa com cintas de inviolabilidade o conjunto fica completamente fechado, dado que a caixa não tem aberturas junto às pegas.

66 Ltrs

100/ 1.2m
1m

 ■ ■ Ref. 2351_	 ■ Ref. 2353_	 ■ Ref. 2352_
Fechada	Fundo fechado e lados gradeados	Gradeada
DIM. (ext.) 600 x 400 x 350mm (int.) 490 x 340 x 347mm		

Base com rodízios (600 x 400 mm)

Tampa (600 x 400 mm)

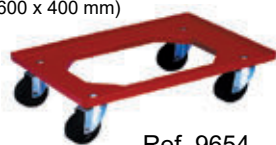

Ref. 9654_



Ref. 9656_



Ref. 3006_

35 Ltrs

140/ **Ref. 1201**

Fechada

140/ **Ref. 1202**

Gradeada

DIM.

(ext.) 600 x 400 x 200mm (int.) 530 x 340 x 172mm

Empilháveis e também encaixáveis em vazio para minimizar o volume ocupado.

O sistema de empilhamento sobre arcos posicionáveis permite maximizar o volume interior.

Inclui alojamento para etiquetas.

Sob consulta podem fabricar-se com paredes gradeadas e fundo fechado, ou vice-versa.

53 Ltrs

305mm

175mm

Ref. 1305	Ref. 1306
Com abertura	Com portinhola

130/ **Ref. 1301**

Fechada

130/ **Ref. 1305 /1306**

130/ **Ref. 1302**

Gradeada

DIM.

(ext.) 600 x 400 x 300mm (int.) 530 x 340 x 272mm

Base com rodízios (600 x 400 mm)



Ref. 9654_



Ref. 9656_

Tampa (600 x 400 mm)



Ref. 3006_

Caixa toda gradeada



Ref. 9610_

Ref. 9611_

Ref. 9612_

DIM. (ext.) 600 x 400 x 59mm
(int.) 580 x 380 x 57mm

DIM. (ext.) 600 x 400 x 77mm
(int.) 580 x 380 x 75mm

DIM. (ext.) 600 x 400 x 92mm
(int.) 580 x 380 x 90mm

Caixa toda fechada



Ref. 9613_

Ref. 9614_

Ref. 9615_

DIM. (ext.) 600 x 400 x 59mm
(int.) 580 x 380 x 57mm

DIM. (ext.) 600 x 400 x 77mm
(int.) 580 x 380 x 75mm

DIM. (ext.) 600 x 400 x 92mm
(int.) 580 x 380 x 90mm

Versões

Sem cantos	C/ cantos baixos	C/ cantos altos
------------	------------------	-----------------



altura / height / alto (mm)

59	77	92
----	----	----

Adequada para o transporte e armazenagem dos mais diversos produtos (pão, bolos, queijos, carnes, hamburguers, massas, frutos, legumes, etc.).

As versões 9612_, 9615_, 9616_ e 9617_ são standard e estão disponíveis para entrega imediata.

Fundo fechado e lados gradeados



Ref. 9616_

Ref. 9617_

Ref. 9618_

DIM. (ext.) 600 x 400 x 59mm
(int.) 580 x 380 x 57mm

DIM. (ext.) 600 x 400 x 77mm
(int.) 580 x 380 x 75mm

DIM. (ext.) 600 x 400 x 92mm
(int.) 580 x 380 x 90mm

Sob consulta: Personalização com o nome da sua empresa, morada ou logótipo.

Fundo gradeado e lados fechados



Ref. 9631_

Ref. 9632_

Ref. 9633_

DIM. (ext.) 600 x 400 x 59mm
(int.) 580 x 380 x 57mm

DIM. (ext.) 600 x 400 x 77mm
(int.) 580 x 380 x 75mm

DIM. (ext.) 600 x 400 x 92mm
(int.) 580 x 380 x 90mm

Base com rodízios (600 x 400 mm)



Ref. 9654_

Tampa (600 x 400 mm)

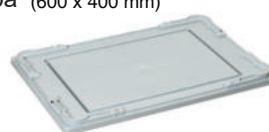

Ref. 3006_

CAIXAS EMPILHÁVEIS

Originalmente concebidas para as indústrias de queijo e pastelaria, são também usadas para outras aplicações que requerem dimensões diferentes de 600x400mm ou de 400x300mm.

A tampa Ref. 7860_ é adequada para a Ref. 7870_ ou para a Ref. 7871_ e possibilita o empilhamento estável de uma rima de caixas Ref. 9280_ ou 2 rimas de caixas Ref. 9015_

Ref.	DIM. (ext.)	DIM. (int.)
7870_	680x450x120mm	615x410x110mm
7871_	680x450x152mm	615x410x142mm
9015_	435x300x95mm	400x275x75mm
9280_	500x320x105mm	460x300x85mm
7860_	Tampa <i>Lid</i>	Tapa



Originalmente desenvolvida para o transporte de peixe, é também usada para pão de forma e para outras aplicações que requerem dimensões específicas distintas de 600x400mm.

Caixa para peixe

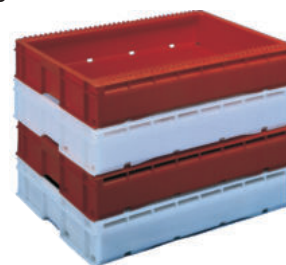

DIM.
Ref. 9500_ (ext.) 725 x 485 x 130mm (int.) 680 x 475 x 118mm

Caixa empilhável



Ref. 332_

DIM.
(ext.) 500 x 310 x 255mm (int.) 470 x 280 x 245mm

Caixa empilhável



17L

Ref. 8470_

DIM.
(ext.) 400 x 300 x 170mm (int.) 370 x 270 x 165mm

Base com rodízios (600 x 400 / 680 x 450 mm)

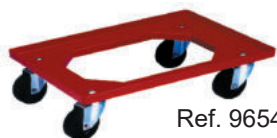

Ref. 9654_

Tampa (680 x 450mm)

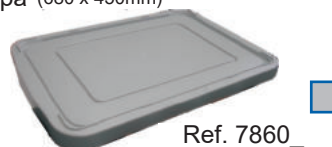

Ref. 7860_

PSAplast
.com

Plásticos Santo António, Lda.
P.O. Box 21, 2416 - 901 Leiria, Portugal

Tel. 00-351-244 81 36 00
Fax. 00-351-244 81 22 21

comercial@psaplast.com

CAIXA ENCAIXÁVEL

Caixa encaixável



Ref. 9450_

DIM.
540mm x 380mm x 80mm

Caixa usada para controlo de bagagem de mão em aeroporto



PSAplast
.com

Plásticos Santo António, Lda.
P.O. Box 21, 2416 - 901 Leiria, Portugal

Tel. 00-351-244 81 36 00
Fax. 00-351-244 81 22 21

comercial@psplast.com

CAIXAS COM OU SEM GRELHAS

Caixa encaixável disponível com ou sem grelhas

Caixa sem grelhas



Ref. 9450_

DIM.
540 x 380 x 80mm

Caixa com 2 grelhas

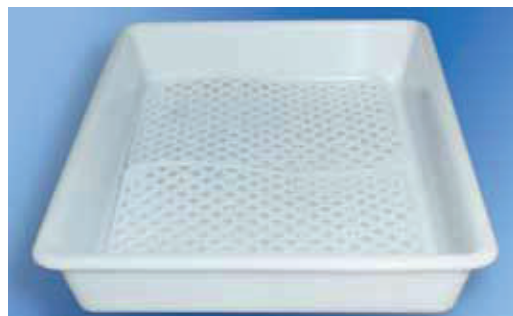

Ref. 9451_

DIM.
540 x 380 x 80mm



Caixa empilhável/encaixável com 2 grelhas e com tampa



Ref. 9452_

Grelha (295x230x13mm)

Caixa empilhável/encaixável + 2 grelhas Ref. 9452_



Ref. 3006_

Tampa (600x400mm)

Ref. 9901_

DIM.
600 x 400 x 150mm

PSAplast
.com

Plásticos Santo António, Lda.
P.O. Box 21, 2416 - 901 Leiria, Portugal
Tel. 00-351-244 81 36 00
Fax. 00-351-244 81 22 21

comercial@psaplast.com

CAIXAS PARA VINDIMA

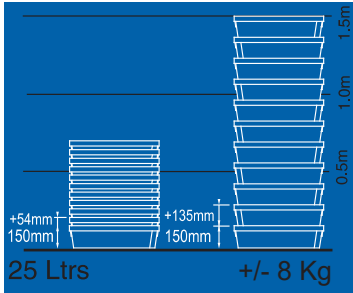
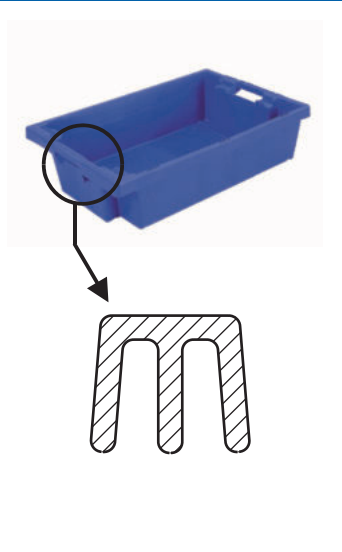

Fechada

Ref. 9901_

DIM. 600 x 400 x 150mm 195/ 

As caixas são empilháveis. Pode empilhar várias caixas sem esmagar as uvas, evitando a sua fermentação antecipada.

Dando meia volta às caixas elas passam a encaixar umas dentro das outras quando vazias, oferecendo uma grande facilidade de manuseamento, e economia de espaço.

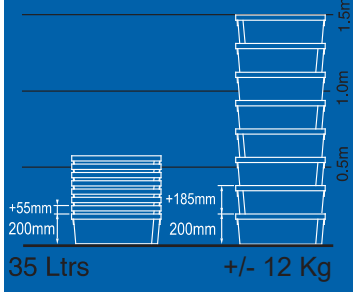

Fechada

Ref. 9701_

DIM. 600 x 400 x 200mm 190/ 

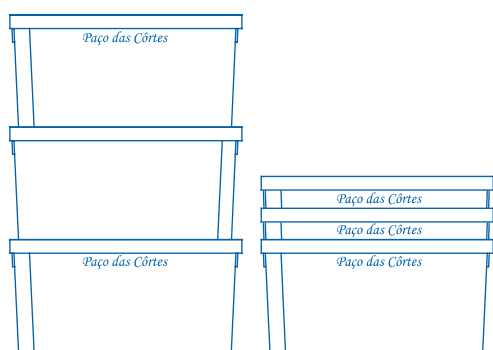

Optando pela gravação de 1 lado fica assegurada a fácil distinção entre a posição de empilhamento e a posição de encaixe:

- para empilhamento, a gravação fica alternada.
- para encaixe, as gravações ficam todas do mesmo lado.

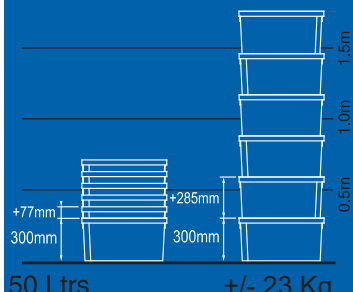

Fechada

Ref. 9751_

DIM. 600 x 400 x 300mm 130/ 

Os pesos indicados são valores aproximados (o valor exato dependerá da forma e tamanho dos cachos de uvas)

Base com rodízios (600 x 400 mm)

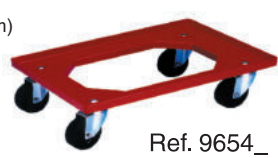

Ref. 9654_

Tampa (600 x 400 mm)



Ref. 3006_

PSAplast.com

Plásticos Santo António, Lda.
P.O. Box 21, 2416 - 901 Leiria, Portugal
Tel. 00-351-244 81 36 00
Fax. 00-351-244 81 22 21

comercial@psaplast.com

Adequada para contato alimentar.

Não adequada para uso em estanteria.

Estas paletes com 9 pés (sem travessas) encaixam umas nas outras. Quando encaixadas, a primeira ocupa 150mm e cada uma das seguintes ocupa uma altura de apenas 45mm.



CARGA	
ESTÁTICA	DINÂMICA
1000 Kg	800 Kg



Ref. 2281_

Paleta



6,9 Kg

DIM.

1200 x 800 x 150mm

Adequada para contato alimentar.

Com 2 travessas.

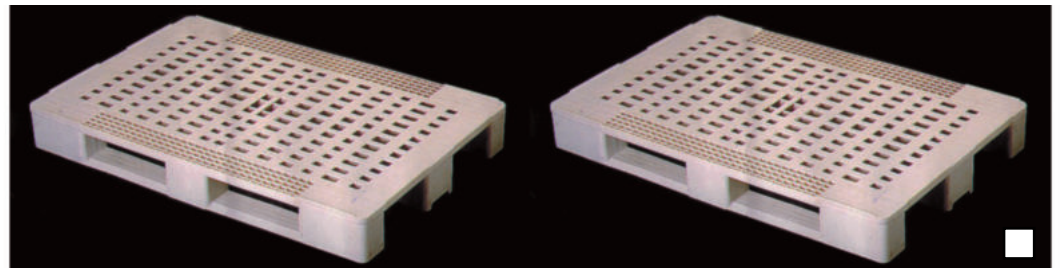

CARGA		
ESTÁTICA	DINÂMICA	ESTANTERIA
1500 Kg	1000 Kg	400 Kg

Ref. 9662_

Paleta



14,4 Kg

DIM.

1200 x 800 x 145mm

Adequados para contato alimentar.



Ref. 9660_

Estrado

DIM.

500 x 500 x 48mm

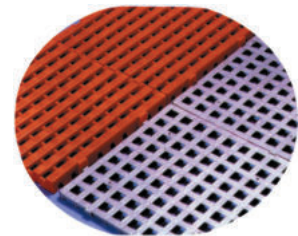

Ref. 9661_

DIM.

500 x 500 x 24mm

DIM.
Ø 480 mm x 670 mm
80 L



Ref. 7900_

Baldão sem tampa



Ref. 7901_

Baldão com tampa

Baldão com pedal

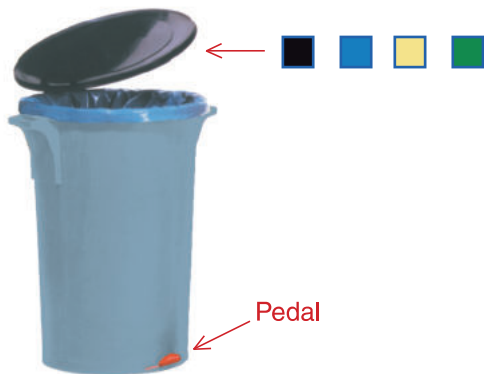

Ref 7907_



DIM.
Ø 480 mm x 670 mm
80L



Ref. 7903_

Baldão com tampa articulada

DIM.
Ø 480 mm x 670 mm
80L

Tampa



Ref. 7902_

Tampa articulada



Ref. 7904_

RECIPIENTES PARA RECOLHA SELECTIVA

Contentor com tampa plana



Ref. 9570

60 L

DIM.

585 x 435 x 360mm

Contentor com pedal



Ref. 9580

60 L

DIM.

730 x 430 x 400mm

Papeleira com tampa basculante



Ref. 9590

60 L

DIM.

680 x 430 x 345mm

Papeleira sem tampa



8 L

295 x 195 x 195mm

Ref. 8900



6,2 L

217 x 160 x 290mm

Ref. 0230



13,5 L

217 x 255 x 290mm

Ref. 0240

Contentor sem tampa



Ref. 7880

60L

DIM.

560 x 425 x 340mm

Papeleiras com tampa vai-vem



Ref. 7950

60L

DIM.

725 x 435 x 345mm



Ref. 9224

40L

DIM.

690 x 420(Ø380)mm



Ref. 8901

8L

DIM.

390 x 200 x 200mm

PSAplast
.com

Plásticos Santo António, Lda.
P.O. Box 21, 2416 - 901 Leiria, Portugal
Tel. 00-351-244 81 36 00
Fax. 00-351-244 81 22 21

comercial@psaplast.com

Balde com tampa inviolável



Patilha de inviolabilidade

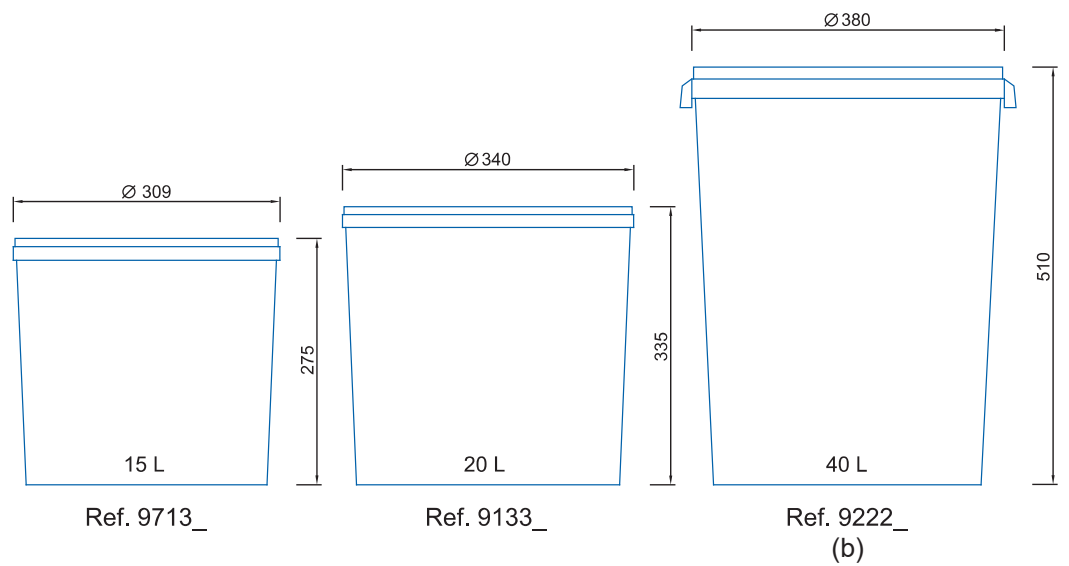
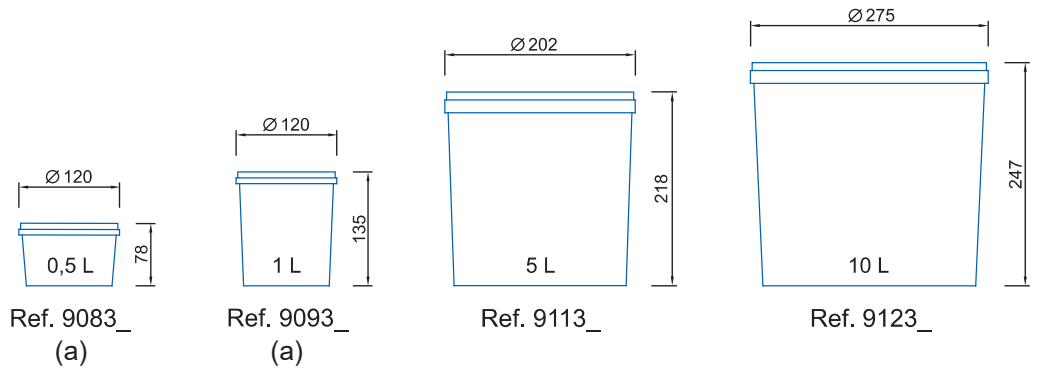

- a) sem asa
- b) com 2 pegas

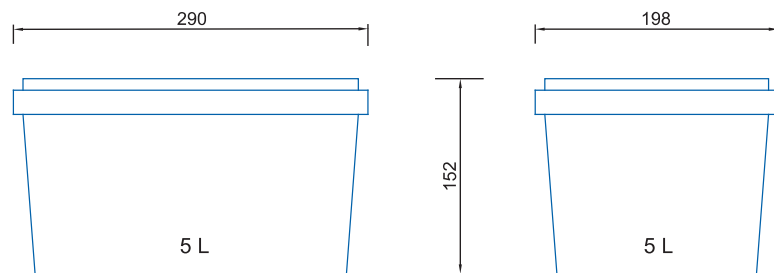

Ref. 9561_

Balde rectangular

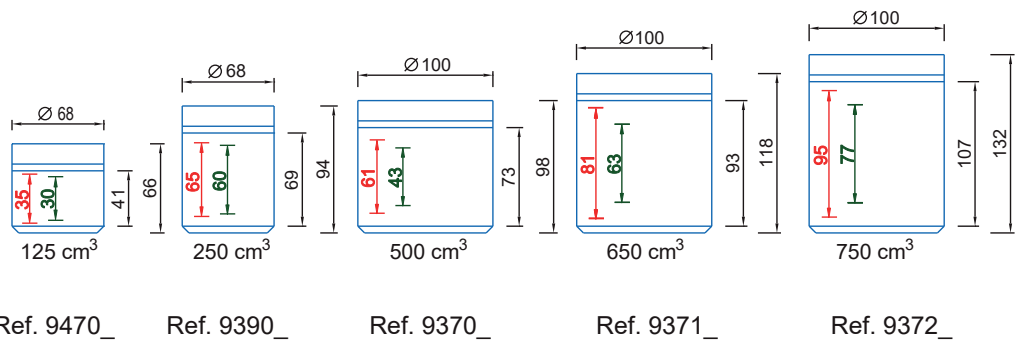

As tampas apresentam uma cinta de inviolabilidade, que é necessário remover para permitir a abertura.

Os Boiões são fabricados em Polietileno de Alta Densidade em branco e as tampas em Polietileno de Baixa Densidade, e são adequados para contacto com alimentos conforme a regulamentação Europeia.

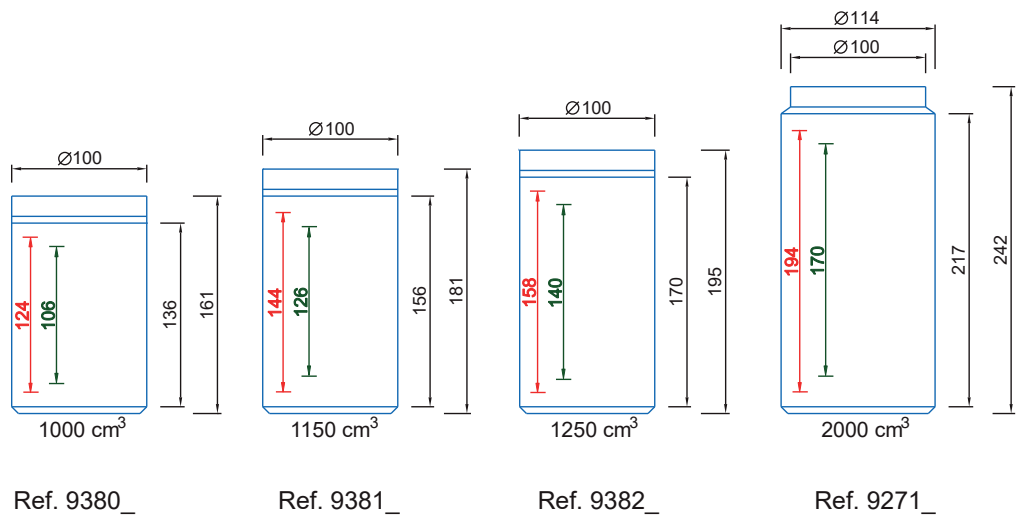

Altura máxima da etiqueta (mm)
 Altura máxima da gravação por serigrafia (mm)

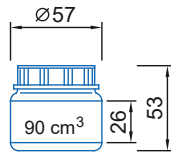

Ref. 6450_

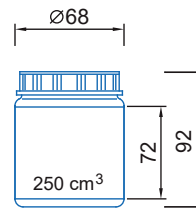

Ref. 1450_

Fabricados com materiais adequados para contacto com alimentos.

EMBALAGENS COM TAMPA INVIOLÁVEL

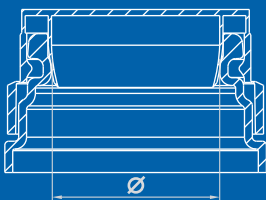
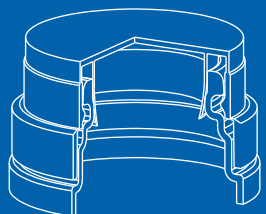

Ref. xyz0_
 Ø27.5mm

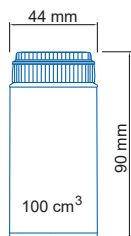

Ref. 9060_

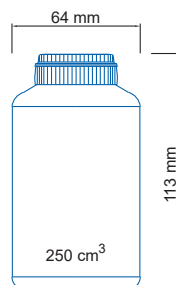

Ref. 9200_

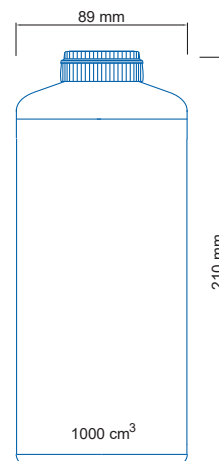

Ref. 9230_

Tampa inviolável colocável à pressão.

As embalagens que têm o 4º algarismo da referência igual a "0", têm um gargalo com 27,5mm de diâmetro.

Recomenda-se a realização de ensaios para verificar a resistência química ao produto embalado.

* Pode fabricar-se em versão 4 Ltrs (Ref.9430_), sendo a altura de 270mm em vez de 300mm.

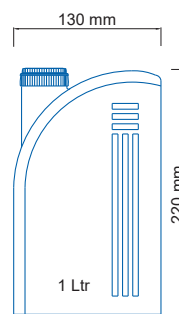

Ref. 9480_

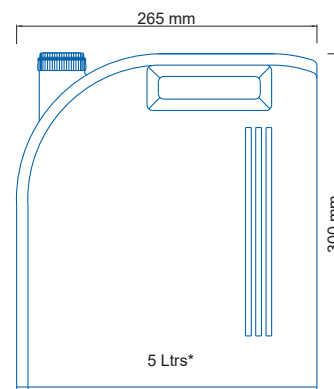

Ref. 9440_

PSAplast
 .com

Plásticos Santo António, Lda.
 P.O. Box 21, 2416 - 901 Leiria, Portugal

Tel. 00-351-244 81 36 00
 Fax. 00-351-244 81 22 21

comercial@psaplast.com

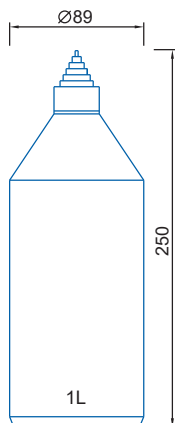
Frascos
com tampa
de bico

Ref. 9231_

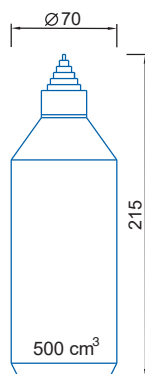

Ref. 9141_

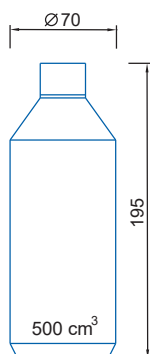

Ref. 9021_

Frasco
com tampa de
rosca inviolável

Ref. 9143_

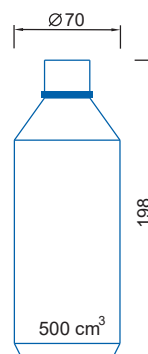
Frasco inviolável
com tampa de
segurança para
crianças

Ref. 9144_

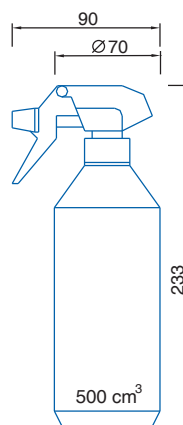
Frasco com
pulverizadorPara todos os frascos e pistola
pulverizadora recomenda-se a
realização de ensaios para
verificar a resistência química
ao produto embalado.

Ref. 9142_



Ref. 8680_ (Não inclui a pinça)
Boleira (450x300x120mm)



Ref. 8332_

Ref. 8882_

Ref. 2092_

Ref. 2800_

Bandeja (480x370mm)

Bandeja (530x325mm)

Bandeja (410x330mm)

Bandeja redonda (Ø315mm)



Ref. 8201_

Mesa de ir à cama (590x400mm)



Ref. 7992_

Tabuleiro TV (480x295mm)



Ref. 9490_
Tabuleiro talher (400x355x50mm)



Ref. 8190_

Balde limpeza profissional (460x310x240mm) 15L



Ref. 9563_

Caixa retangular (290x155x170mm) 5L



Ref. 8691_
Ref. 8701_

185x125x70mm
235x150x95mm



Ref. 2910_
Ref. 2920_

122x53x22mm
156x55x34mm

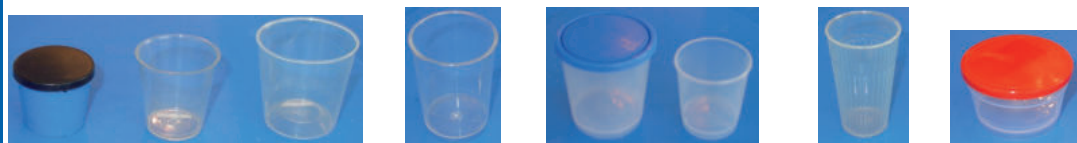

Ref. 250_

Ref. 211_

Ref. 252_

Ref. 416_

Ref. 352_

Ref. 351_

Ref. 398_

Ref. 771_

46x37mm
37,5cm3

49x50mm
60cm3

59x55mm
87,5cm3

59x80mm
137,5cm3

92x105mm
480cm3

75x85mm
240cm3

70x125mm
340cm3

72x43mm
100cm3



Ref. 9530_
Jarro de 1L graduado



Ref. 4440_

Caixa redonda (40x24 mm) 26 ml



Ref. 0180_

Colher doseadora (15 cm3)



Ref. 0810_

Espadas (palito)



Ref. 3060_

Vareta (15,5 cm)

PSAplast
.com

Plásticos Santo António, Lda.
P.O. Box 21, 2416 - 901 Leiria, Portugal

Tel. 00-351-244 81 36 00
Fax. 00-351-244 81 22 21

comercial@psaplast.com

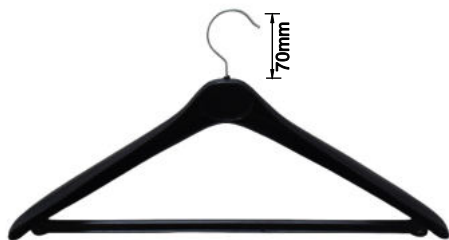

Cabide com gancho

Ref. 8910_



Cabide com espigão anti-roubo

Ref. 8911_

Argola metálica para cabides com espigão anti-roubo



Argola plástica para cabides com espigão anti-roubo. Aplicável sem desmontar o varão

Ref. 8913_

Ref. 8914_

DIM.
A 420 mm X B 30 mm

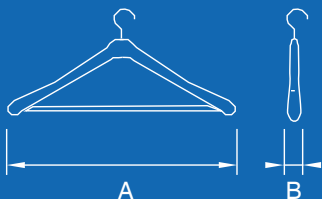

Placas Gravadas com Logotipo



Ref. 8010_

Cabide

DIM.
A 410 mm X B 9 mm



Ref. 8810 _

Modelo simples (vazio)

DIM.

240mm x 190mm x 95mm



Ref. 8342 _

Modelo Simples (vazio)

DIM.

460mm x 310mm x 370mm